



SCHREINEREI • MENUISERIE

Hoffmann

HOLZ IN PERFEKTION





SCHREINEREI HOFFMANN

Seit 60 Jahren und nunmehr bereits in der dritten Generation gilt die Schreinerei HOFFMANN aus Lengeler als Spezialist in Sachen Holzverarbeitung und hat sich im Laufe der Jahre, weit über die Grenzen des kleinen Ardennendorfes hinaus, einen guten Namen erworben.

Schreinerei HOFFMANN steht somit heute als Garant für qualitativ hochwertige Produkte, ob bei kleinen oder auch großen Projekten. Die Produktpalette ist sehr umfangreich und reicht von Fensterrahmen über Türen und Tore bis hin zu Treppen und Inneneinrichtungen.

Joseph HOFFMANN und seine Mitarbeiter verfügen über eine 3.000 m² große Werkstatt mit einem modernen, leistungsstarken Maschinenpark, in der sie von den ausgefallensten Möbeln bis hin zu kompletten Einrichtungen aus feinstem Holzschnittwerk einfach alles realisieren können.



MENUISERIE HOFFMANN

Depuis sa création il y a 60 ans, trois générations de spécialistes du travail du bois se sont succédées à la menuiserie HOFFMANN à Lengeler. Au fil des années, l'entreprise familiale s'est forgée une excellente réputation qui s'étend bien au-delà des frontières du petit village ardennais.

Le nom HOFFMANN est aujourd'hui synonyme de qualité supérieure, quelle que soit l'envergure du projet. La gamme des produits est particulièrement vaste: châssis de fenêtres, portes, portes de garage, parquets, escaliers, mobilier et plafonds.

Joseph HOFFMANN et ses collaborateurs disposent d'un atelier de plus de 3.000 m², équipé de machines modernes et performantes, qui leur permet de réaliser aussi bien les meubles les plus originaux que des aménagements complets en bois sculptés.





INNENTÜREN

Innentüren bestimmen wesentlich den Charakter eines Raumes. Ob Standard, Modern, Elegant oder Klassisch – wir haben für jeden Einrichtungsstil das Passende.

So persönlich wie Ihre Wohnwelt ist, so individuell sind die Türen die wir für Sie herstellen. Massivholztüren in Eiche, Kirschbaum oder Nussbaum – geölt oder lackiert – Türen in Edelholzfurnier mit Massivholzeinlage und massiven Anleimern, Glaselemente, raumhohe Ausführungen, Innentüren mit flächenbündigen Rahmenkonstruktionen, Schiebetüren, 2-flügelige Türen, Blendrahmenelemente, Korb- Rund- und Stichbogen -Individualität ist eine unserer Stärken!

Unsere Türmaßen unterliegen keiner Norm, sodass wir auch im Renovierungsbereich ein flexibler Partner bei der Verwirklichung Ihrer Wünsche sind.

Damit Türen Ihren Zweck erfüllen können, muss auch die Zarge entsprechend konstruiert sein. Wichtig sind Stabilität, Verzugfestigkeit und Widerstandsfähigkeit.

Damit die handwerkliche Qualität bis ins letzte Detail gewährleistet bleibt, endet unser Auftrag nicht bei der Herstellung, sondern mit der Montage vor Ort. Wir legen Wert auf höchste Sorgfalt und passgenaue Justierung.

Bei all unsern Produkten dieser Broschüre sind technische Änderungen vorbehalten. Die Nutzung der Bilder wird nur durch Zustimmung der Firma Hoffmann erlaubt.



PORTES INTÉRIEURES

Les portes intérieures déterminent essentiellement le caractère d'une pièce. Standard, moderne, élégant ou classique, nous avons l'assorti pour chaque style d'intérieur.

Les portes que nous construisons pour vous sont aussi personnelles que votre intérieur. Portes massives ou plaquées, en chêne, merisier ou noyer – huilé ou laqué – éléments en verre, des réalisations à hauteur d'étage, à construction affleurée, portes coulissantes, portes à double battants, dormants, courbés et cintrés. L'individualité est un de nos points forts!

Nos mesures de porte ne sont pas soumises à la norme, ce qui fait de nous un partenaire flexible dans les travaux de rénovation suivant vos désirs. Pour répondre aux exigences d'une porte, le cadre doit être construit de façon adéquate. La stabilité, la résistance à la déformation et la capacité de résistance sont importantes.

Pour garantir une qualité artisanale détaillée et ajustée, nos menuisiers exécutent le montage des portes avec diligence, précision et propreté.

L'ensemble de nos produits de cette brochure sont sous réserve de modifications techniques. L'utilisation de toutes les images est autorisée que par l'accord de la société Hoffmann.



ZI-4



MASSIVE STILTÜREN

PORTES STYLE MASSIVE



ZT-1



ZT-2



ZT-3



ZT-3 mit Glas



ZT-3 mit Bleiverglasung



ZT-4



ZT-7



ZT-8



MASSIVE STILTÜREN



ZT-11



ZT-12



ZT-13 mit Schnitzerei



ZT-14



ZT-14 mit Glas



ZT-14 mit Glas



ZT-16



ZT-16 mit Glas



PORTES STYLE MASSIVE



ZT-17



ZT-18



ZT-19



ZT-20



ZT-21



ZT-22



ZT-23 mit Schnitzerei



ZT-25





ZT-14 HMF mit Glas als Doppeltür

ZT-14 HMF porte à double battants avec vitrage et croisillons



KLASSISCHE FURNIERTE TÜREN

PORTES SEMI-MASSIVE



ZT-3 HMF



ZT-3 HMF mit Glas



ZT-4 HMF



ZT-7 HM



ZT-8 HMF



ZT-14 HML



ZT-14 HMF mit Glas



ZT-16 HMF





ZT-27 • Eine hochwertige Tür in Kirschbaum massiv mit 4 Füllungen sowie Rundbogen und in der Mitte mit einem schönen diagonalen Kastenmotiv. Mehr als eine Tür – fast schon ein Möbelstück. Unten: eine Variation mit Glasfüllung und 1 Festelement an den Seiten.

ZT-27 • Une porte massive en bois de merisier, forme arrondie avec 4 panneaux et au milieu un beau motif mise en diagonale. Plus qu'une porte – presque un meuble. En bas: Une variation avec du verre et 1 élément fixe aux côtés.



MODERNE MASSIVTÜREN

PORTES MODERNES MASSIVES



ZT-28



ZT-29



ZT-30

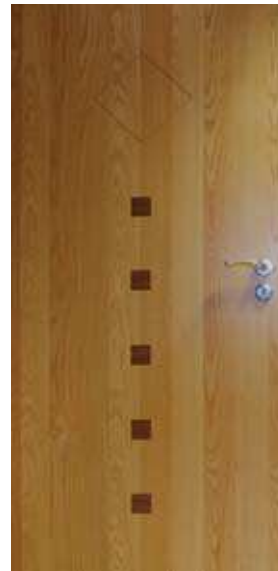

ZT-31



ZT-32



ZT-33



ZT-34



ZT-35



MODERNE MASSIVTÜREN



ZT-48



ZT-49



ZT-53



ZT-56



ZT-58



ZT-59



ZT-60



ZT-61



PORTES MODERNES MASSIVES



ZT-62



ZT-63



ZT-64



ZT-65



ZT-66



ZT-67



ZT-26



ZT-69



MODERNE FURNIERTE TÜREN

PORTES MODERNES PLAQUEES



ZT-37



ZT-38



ZT-39



ZT-40



ZT-42



ZT-43



ZT-44



MODERNE FURNIERTE TÜREN



ZT-65



ZT-66



ZT-67



ZT-68



ZT-70



ZT-71



PORTES MODERNES PLAQUEES



ZT-72



ZT-73



ZT-74



ZT-76



ZT-77



ZT-78



ZT-79



MODERNE FURNIERTE TÜREN



ZT-80



ZT-82



ZT-84



ZT-85



ZT-86



ZT-87





ZI-96



MODERNE LACKIERTE TÜREN

PORTES MODERNES LAQUEES



ZT-97



ZT-98



ZT-99

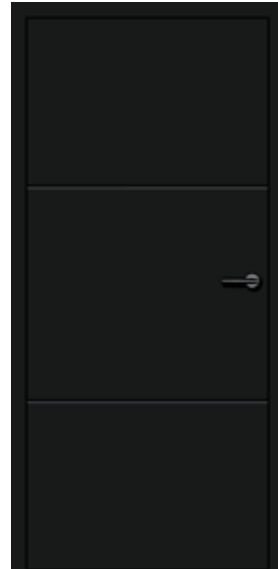

ZT-100

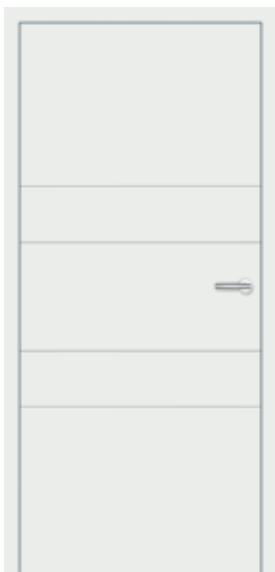

ZT-101



ZT-102



ZT-103

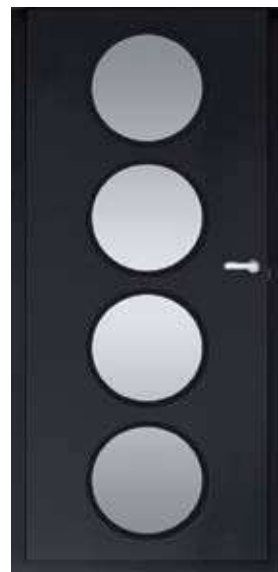

ZT-104





ZI-105 G



GLASTÜREN

PORTES EN VERRE



ZT-106 G



ZT-107 G



ZT-108 G



ZT-109 G



GLASTÜREN



ZT-114 G



ZT-115 G



ZT-116 G



ZT-117 G

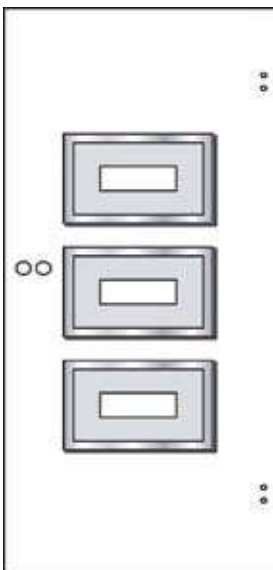

ZT-118 G

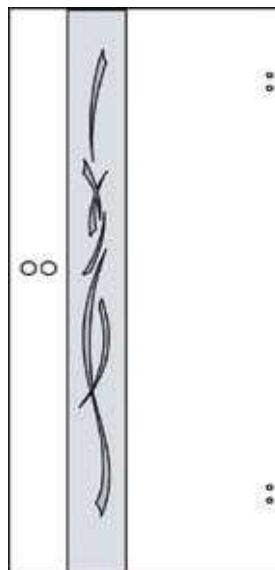

ZT-119 G

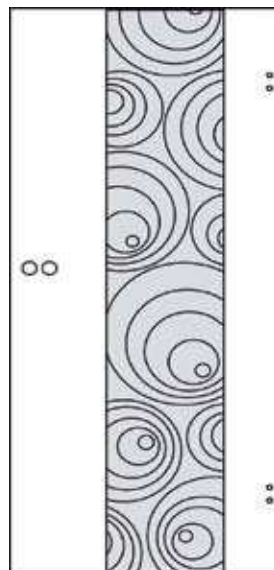

ZT-120 G

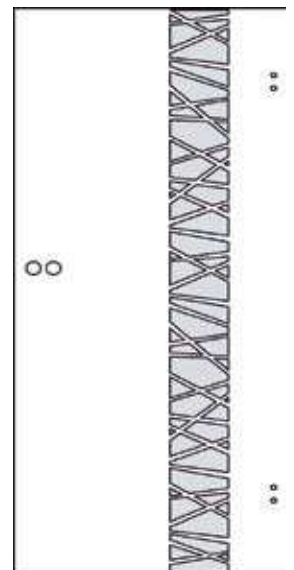

ZT-121 G



PORTES EN VERRE

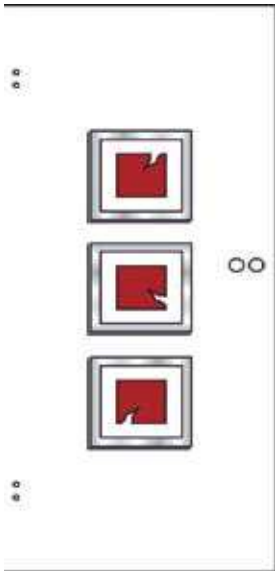

ZT-122 G

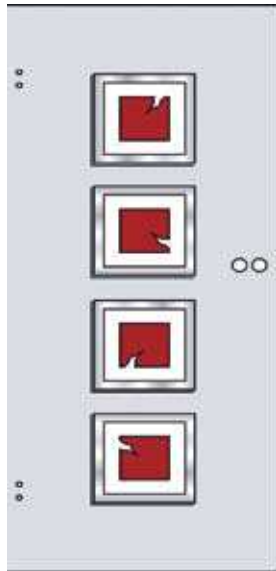

ZT-123 G

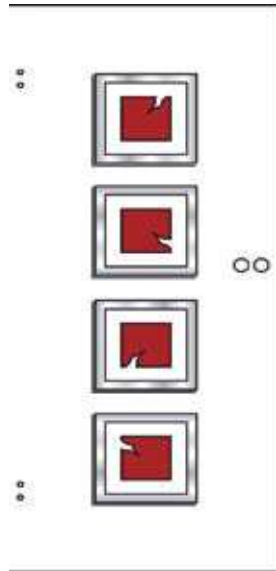

ZT-124 G



ZT-125 G

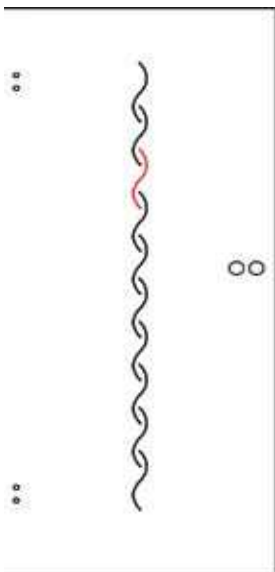

ZT-126 G

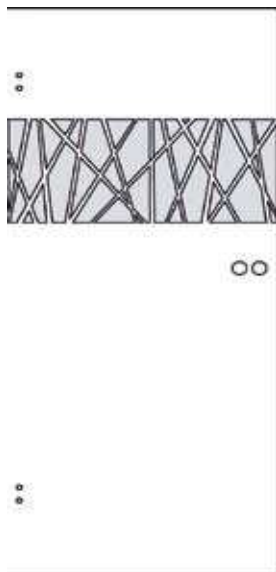

ZT-127 G

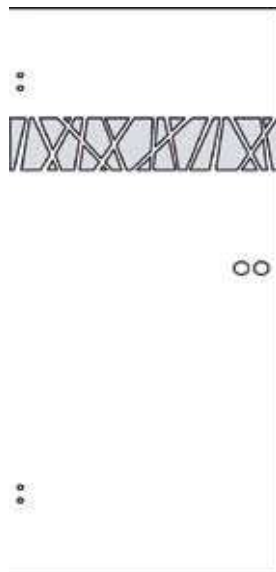

ZT-128 G

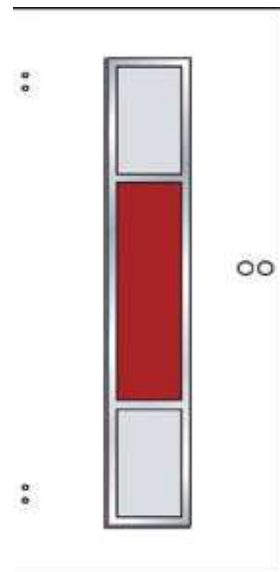

ZT-129 G



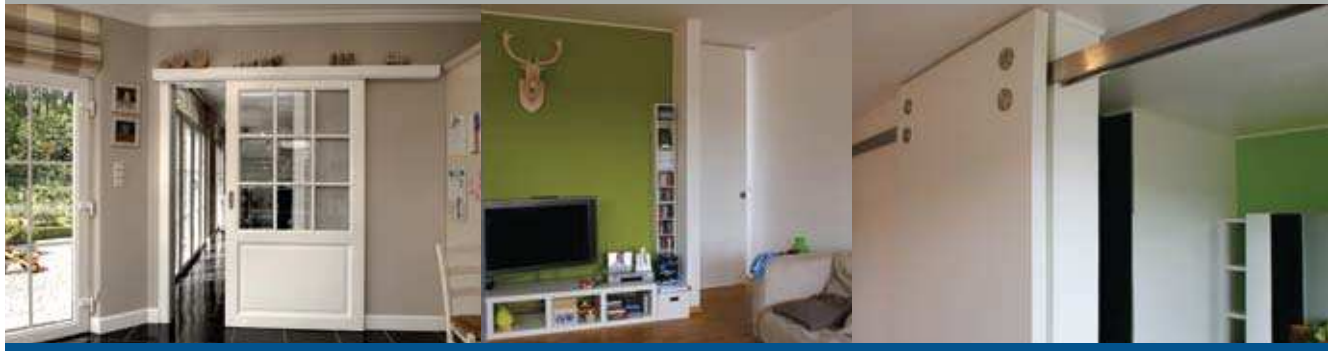



SCHIEBETÜREN PORTES COULISSANTES





In unserem Showroom in Marnach finden Sie eine riesige Auswahl an Türdrücker. Auch hier gibt es für jede Stilrichtung das Passende – ob rustikal oder modern.

Dans notre salle d'exposition à Marnach, vous trouvez un grand choix de poignées de porte. Il y a tous les styles – du rustique au moderne.



EINIGE MUSTER VON TÜRDRÜCKERN

QUELQUES MODÈLES DE POIGNÉES



D-1



D-2



D-3



D-4



D-5



D-6



D-7



D-8



D-9



D-10



D-11



D-12



D-13



D-14



D-15



D-16



D-17



D-18



D-19



D-20



D-21



D-22



D-23



D-24



D-25



D-26



D-27



D-28



D-29



D-30





TÜRBÄNDER UND EXTRAS

CHARNIÈRES ET EXTRAS



Einbohrband mit modernem Zierkopf
Fiche avec tête moderne



VARIANTE VX – Das variable Bandsystem für Wohnraumtüren
VARIANTE VX – Le système de charnière variable pour portes intérieures



TECTUS – Das variable komplett verdeckt liegende Bandsystem
TECTUS – Le système de charnière invisible



BAKA – Das Bandsystem für schwere Türen
BAKA – Le système de charnière pour portes lourdes



Einbohrbänder mit klassischem Zierkopf
Fiches avec tête style classique



Einbohrband mit modernem Zierkopf
Fiche avec tête moderne



Verschiedene Modelle
Différents modèles



Eingebauter Türschliesser
Ferre-porte encastré



Elektro-Magnet
Electro-aimant



Unsichtbare Kabelführung
Passe-câble invisible



Türschloss mit Kartenleser
Serrure avec lecteur badge





TÜRZARGEN

CHAMBRANLES ET ÉBRASEMENTS



TZ-01



TZ-02

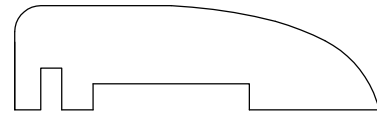

TZ-03

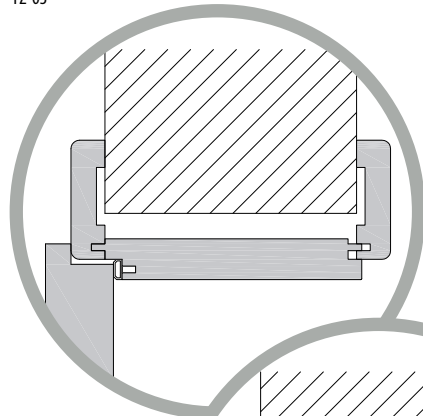

TZ-04

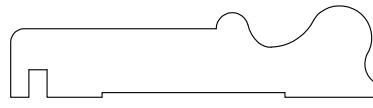

TZ-05

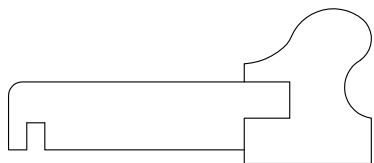

TZ-06

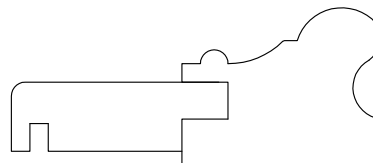

TZ-07

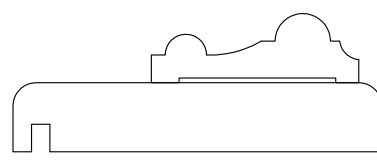

TZ-08





SCHREINEREI • MENUISERIE

Hoffmann

HOLZ IN PERFEKTION

SEIT
1951



www.schreinerei-hoffmann.com

